

HIGH EFFICIENCY VERTICAL MULTISTAGE CENTRIFUGAL PUMP

Series: **HMV95-60-2003**
20 HP



* Representative image

TECHNICAL DATA								
MODEL	PART No.	HP	RPM	V	MAX. AMPS	MAX. TEMP. (°F)	MAX. Q (gpm)	MAX. H (ft)
HMV95-10-303	70120111A	3	3500	230/460	7.9/3.9	248	140	82
HMV95-20-753	70120111B	7.5	3500	230/460	18.3/9.1	248	140	180
HMV95-30-1003	70120111C	10	3500	230/460	24.7/12.3	248	140	255
HMV95-40-1503	70120111L	15	3500	230/460	34/17	248	140	340
HMV95-50-1503	70120111D	15	3500	230/460	34/17	248	140	426
HMV95-60-2003	70120111E	20	3500	230/460	46/23	248	140	508
HMV95-70-2503	70120111N	25	3500	230/460	56.5/28.2	248	140	593
HMV95-80-2503	70120111F	25	3500	230/460	56.5/28.2	248	140	681

ITEM	NAME	MATERIAL	AISI/ASTM
1	Motor	-	-
2	Bracket	Ductile cast iron	ASTM A536 65-45-12
3	Seal base	Stainless steel	AISI 304
4	Mechanical seal	SiC/Carbon	-
5	Top diffuser	Stainless steel	AISI 304
6	Diffuser	Stainless steel	AISI 304
7	Support diffuser	Stainless steel	AISI 304
8	Coupling	Ductile iron	ASTM A536 65-45-12
9	Impeller	Stainless steel	AISI 304
10	Cylinder	Stainless steel	AISI 304
11	Shaft	Stainless steel	AISI 304
12	Bearing	Tungsten carbide	-
13	Inducer	Stainless steel	AISI 304
14	Inlet & outlet chamber	Stainless steel	AISI 304
15	Base	Cast iron	ASTM 25B

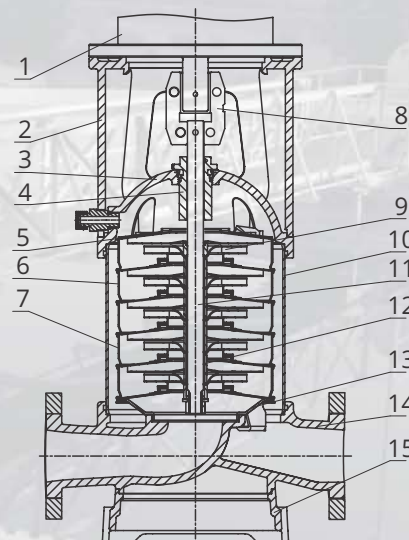

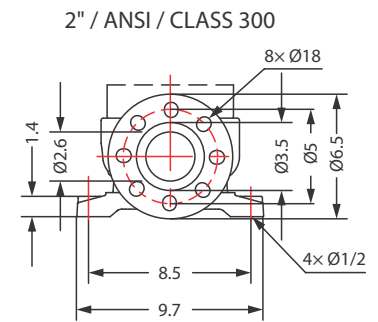
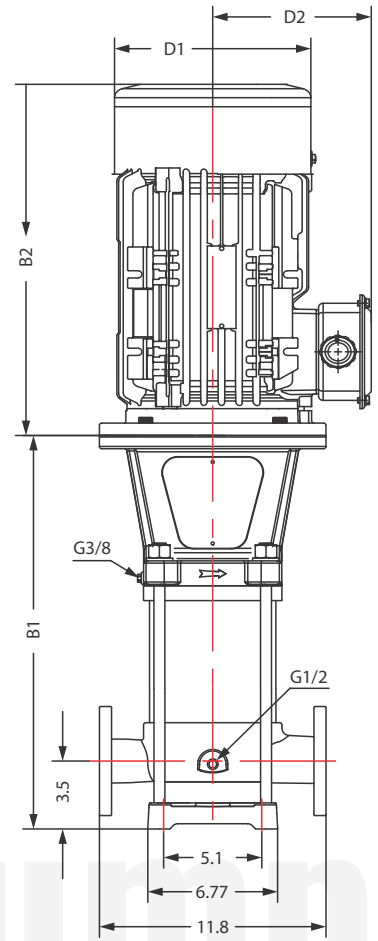
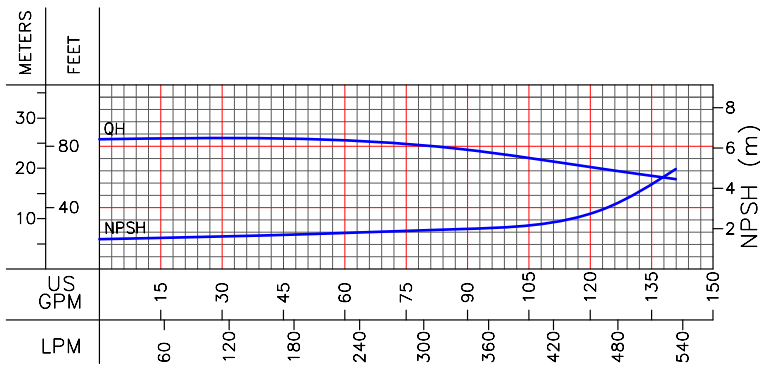
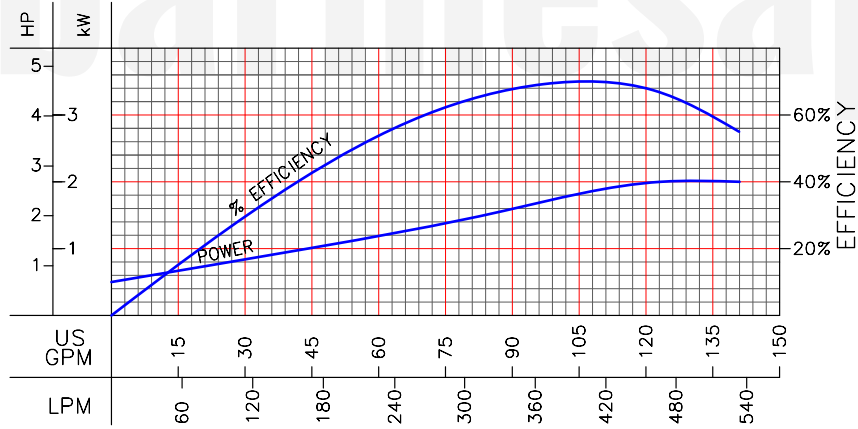
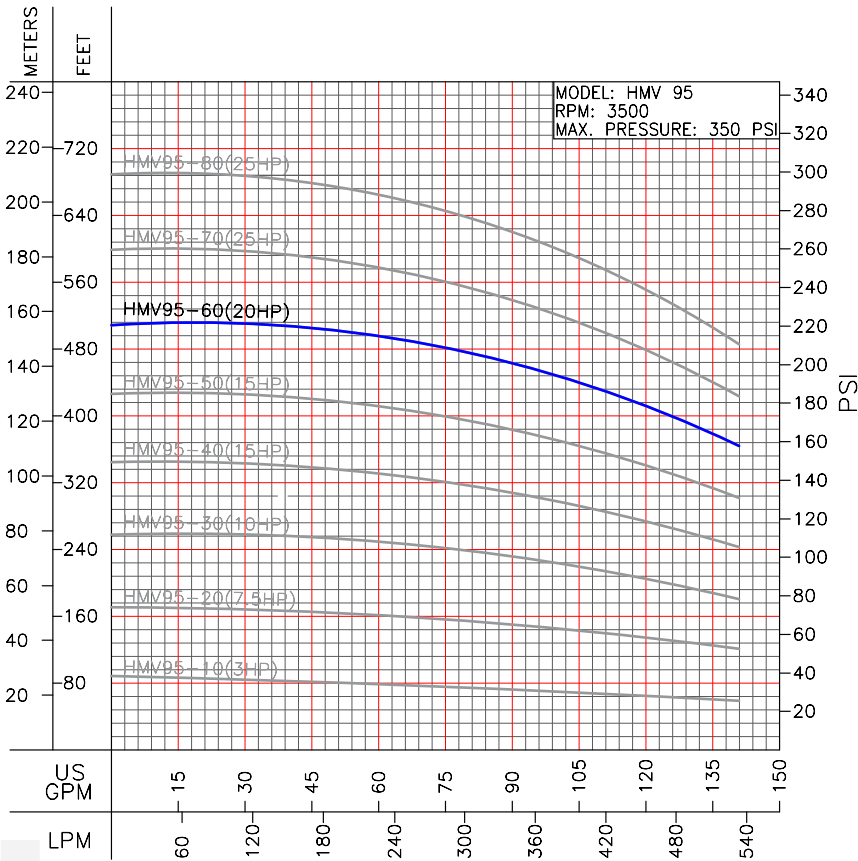

MODEL	HP	STAGES	SIZE (in)				WEIGHT (lb)	
			B1	B2	B1+B2	D1		D2
HMV95-10-303	3	1	14	14	28	7	6	82
HMV95-20-753	7.5	2	17	18	35	10	8	154
HMV95-30-1003	10	3	19	18	37	10	8	168
HMV95-40-1503	15	4	24	24	48	14	10	320
HMV95-50-1503	15	5	26	24	50	14	10	322
HMV95-60-2003	20	6	28	24	52	14	10	324
HMV95-70-2503	25	7	29	25	54	14	10	357
HMV95-80-2503	25	8	31	25	56	14	10	362