

SELF-PRIMING CLOSE COUPLED PUMPS

Series: BSP3CCE, BSP4CCE &
BSP5CCE

1.5, 2 & 3 HP / 3500 RPM

Suction & Discharge: 1½"

Spherical solids handling: 3/8"



Approved for Marine use and
Commercial / Industrial applications.

SUCTION/DISCHARGE

1½" NPT, female.

LIQUID TEMPERATURE

Continuous: 160 °F (71 °C).

INTERMEDIATE

Cast iron ASTM A-48, class 30.

VOLUTE

Cast iron ASTM A-48, class 30.

BODY

Cast iron ASTM A-48, class 30.

BASE

Steel.

IMPELLER

Design: open, trash type, dynamically balanced.

Material: cast iron ASTM A-48, class 30.

SHAFT

416 series stainless steel.

HARDWARE

Steel & stainless steel.

SQUARE RING

Buna-N.

PAINT

Air dry enamel, water based.

SEAL

Design: mechanical, self lubrication.

Material: ceramic stationary part, carbon ring seal and exclusion in the rotating part. Buna-N elastomer and stainless steel spring.

CHECKVALVE

Valve: flap-neoprene

Weight: steel.

MOTOR

Open Drip Proof or **TEFC**, C-face, footed, squirrel cage induction, class B or F insulation.

Single phase: 115/230 volts, 60 Hz, 3500 RPM.

Three phase: 230/460 volts, 60 Hz, 3500 RPM.

OPTIONAL

Bronze fitted volute and impeller.

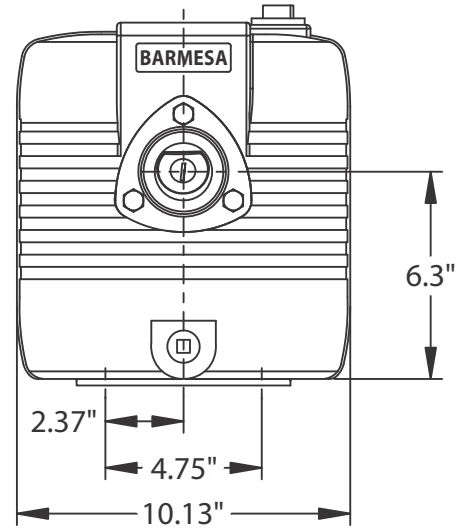
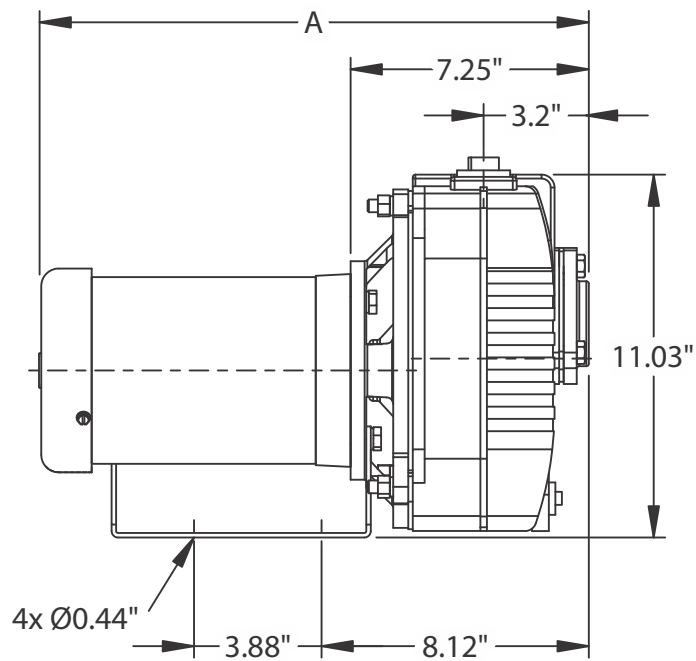

MODEL	PART No.	HP	PHASE	VOLTS	ENCLOSURE	MAX AMPS	A (inches)	WEIGHT (pounds)
BSP3CCE1	62030001	1.5	1	115/230	ODP	13/6.5	18.58	91
BSP3CCE3	62030002	1.5	3	230/460	ODP	5.5 - 4.4/2.2	17.91	84
BSP3CCE1-BF	62030101	1.5	1	115/230	ODP	13/6.5	18.58	91
BSP3CCE3-BF	62030102	1.5	3	230/460	ODP	5.5 - 4.4/2.2	17.91	84
BSP3CCE3-T	62030025	1.5	3	230/460	TEFC	4.9 - 4.6/2.3	17.61	85
BSP3CCE3-TBF	62030122	1.5	3	230/460	TEFC	4.9 - 4.6/2.3	17.61	85
BSP4CCE1	62030003	2	1	115/230	ODP	26/13	17.93	101
BSP4CCE3	62030004	2	3	230/460	ODP	6.4 - 5.4/2.7	18.41	92
BSP4CCE1-BF	62030103	2	1	115/230	ODP	26/13	17.93	101
BSP4CCE3-BF	62030104	2	3	230/460	ODP	6.4 - 5.4/2.7	18.41	92
BSP4CCE1-T	62030023	2	1	115/230	TEFC	23/11.5	19.31	112
BSP4CCE3-T	62030027	2	3	230/460	TEFC	7.0 - 5.4/2.7	18.43	98
BSP4CCE1-TBF	62030123	2	1	115/230	TEFC	23/11.5	19.31	112
BSP4CCE3-TBF	62030124	2	3	230/460	TEFC	7.0 - 5.4/2.7	18.43	98
BSP5CCE1	62030005	3	1	200/230	ODP	29/14.5	18.81	105
BSP5CCE3	62030006	3	3	230/460	ODP	8.5/8.4	18.43	94
BSP5CCE1-BF	62030105	3	1	115/230	ODP	29/14.5	18.81	105
BSP5CCE3-BF	62030106	3	3	230/460	ODP	8.5/8.4	18.43	94
BSP5CCE1-T	62030025	3	1	115/230	TEFC	26/13	20.68	117
BSP5CCE3-T	62030026	3	3	230/460	TEFC	8.1 - 7.6/3.8	18.43	97
BSP5CCE1-TBF	62030124	3	1	115/230	TEFC	26/13	20.68	117
BSP5CCE3-TBF	62030125	3	3	230/460	TEFC	8.1 - 7.6/3.8	18.43	97

T = totally enclosed BF = bronze fitted TB = totally enclosed bronze fitted

* Overall length of unit and amps is subject to the motor manufacture.

IMPORTANT!

1. Never use this pump to handle explosive liquids.
2. This pump is not approved to be used in swimming pools, recreational installations or any application where human contact may be common.



PERFORMANCE CURVE

Self-Priming Close

Coupled Pump

Series: **BSP3CCE**

BSP4CCE

BSP5CCE

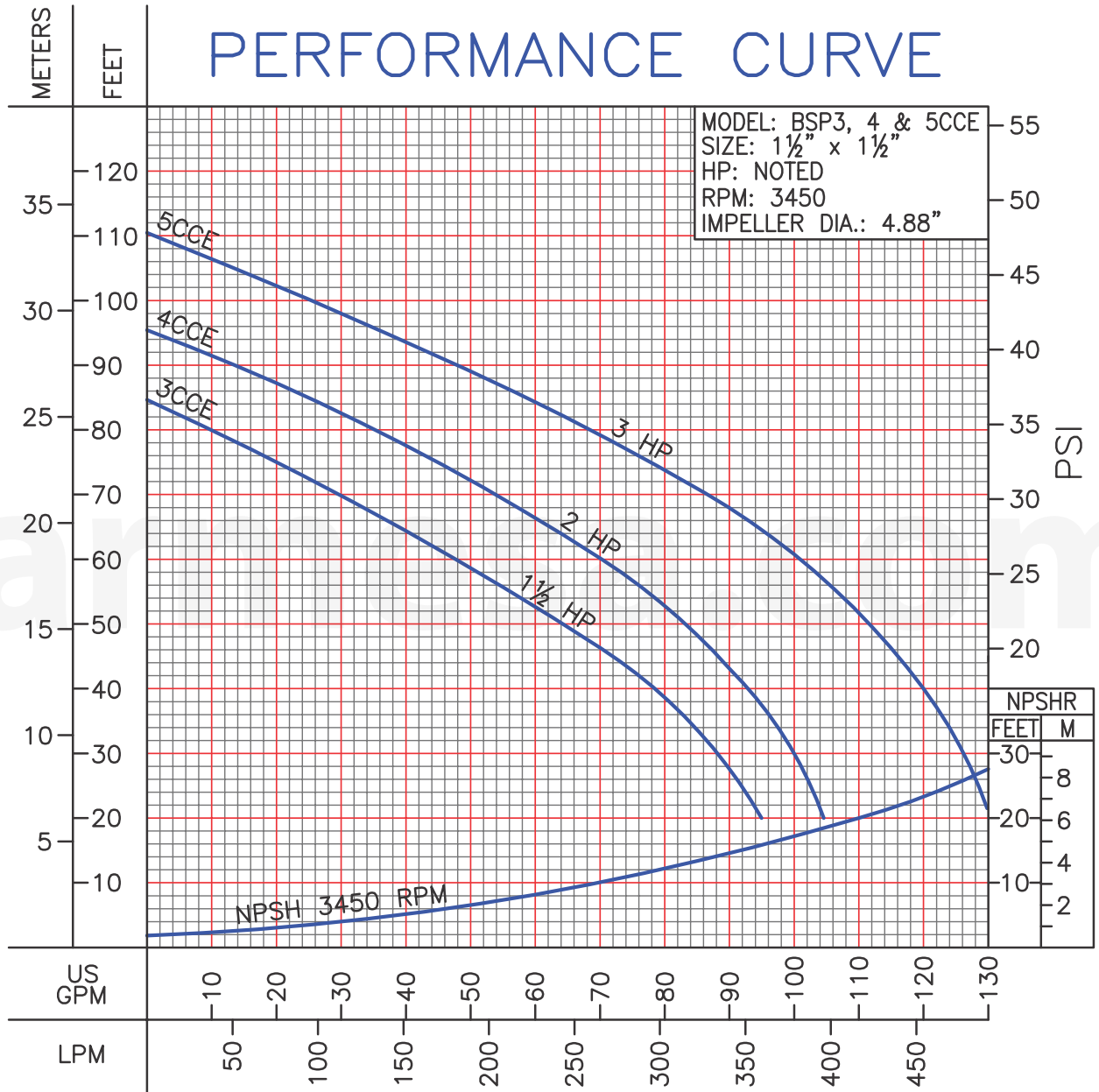

Testing is performed with water specific gravity of 1.0 @ 68 °F (20 °C); other fluids may vary performance.

*BSPCCE series pumps are approved for Marine use and Commercial / Industrial applications.